



## Designs for Composting Systems

**From:**

**Composting: Waste to Resources**

Wooden Box Bin  
Wood and Wire Three-Bin Turning Unit  
Cinder Block Bin  
Cinder Block Turning Unit  
Wire Mesh Bin  
Snow Fence Bin  
Garbage Can Composter  
Worm Composting Bin  
Compost Mound  
Compost Pockets  
Mulch  
Compost Project Record

<http://cwmi.css.cornell.edu/composting.htm>

# Wooden Box Bin

A wooden box bin can be built inexpensively using wooden pallets. Or you can use lumber to make a nicer looking bin. The costs will vary, depending on whether you use pallets or new lumber. Used pallets are often available from manufacturers and landfills.

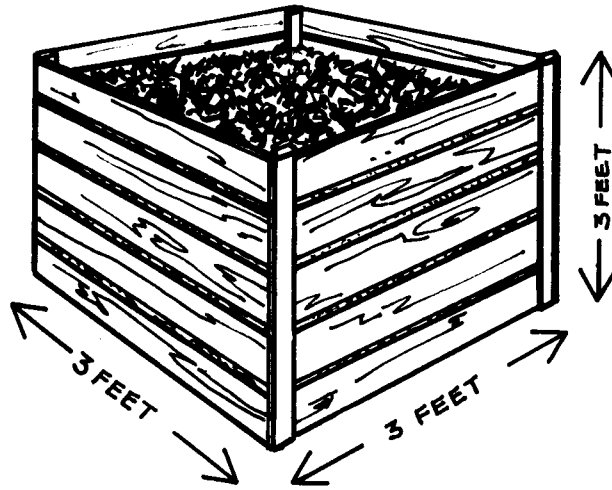

## What You Need

### Materials

- 4 wooden pallets (5 pallets if you want a bottom in the container), sized to make a four-sided container at least 3 feet x 3 feet x 3 feet
- nails
- wire ties
- or*
- 1 12-foot length of 2 x 4 lumber
- 5 12-foot lengths of lumber, 6 X 3/4
- nails

### Tools

- saw
- sledge hammer
- work gloves

## Building a Wooden Box Bin

### If using wooden pallets:

1. Nail or wire four pallets together to make a four-sided container at least 3 feet x 3 feet x 3 feet. The container is ready to use.
2. A fifth pallet can be used as a base to allow more air to get into the pile and to increase the stability of the bin.

### If using lumber:

1. Saw the 12-foot length of 2 x 4 lumber into four pieces, each 3 feet long, to be used as corner posts.
2. Choose a 3-foot-square site for your compost bin, and pound the four posts into the ground 3 feet apart, at the corners of the square.
3. Saw each of the five 12-foot boards into four 3-foot pieces. Allowing five boards to a side and starting at the bottom, nail the boards to the posts to make a four-sided container. Leave 1/2 inch between the boards to allow air to get into the pile.
4. If you wish to decrease your composting time, build a second holding unit so the wastes in one can mature while you add wastes to the other.

## Adding Wastes

Add wastes as they become available. Nonwood materials such as grass clippings and garden weeds work best. You can speed up the process by chopping or shredding the wastes. If you have two units, when the first unit is full let the compost mature and add wastes to the second unit.

## Maintaining Your Compost Pile

Although you do not need to turn this pile, make sure that it is moist during dry spells. Compost should be ready in about one year.

# Wood and Wire Three-Bin Turning Unit

A wood and wire three-bin turning unit can be used to compost large amounts of yard, garden, and kitchen wastes in a short time. Although relatively expensive to build, it is sturdy, attractive, and should last a long time. Construction requires basic carpentry skills and tools.

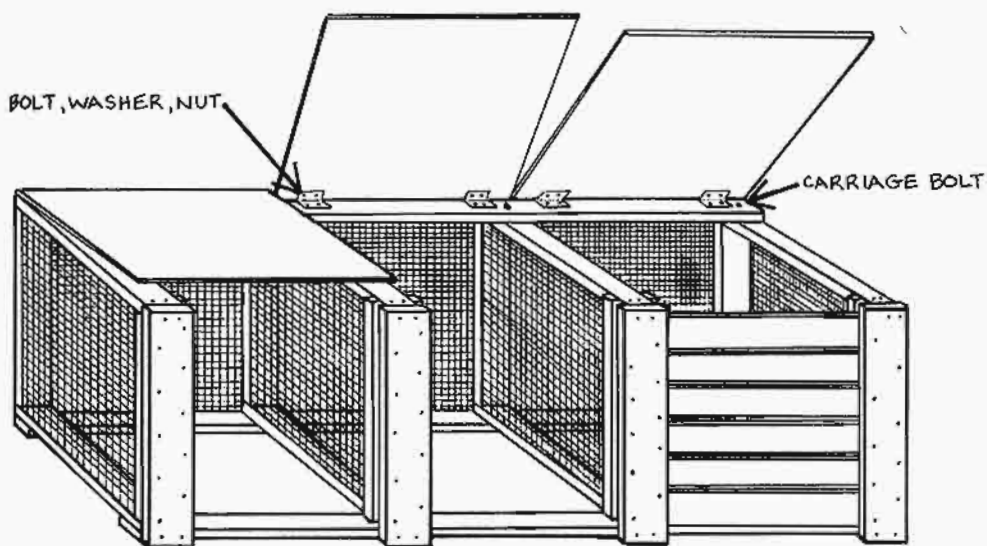

## What You Need

### Materials

- 4 12-foot (or 8 6-foot) lengths of pressure-treated 2 x 4 lumber
- 2 10-foot lengths of pressure-treated 2 x 4 lumber
- 1 10-foot length of construction grade 2 x 4 lumber
- 1 16-foot length of 2 x 6 lumber
- 6 8-foot lengths of 1 x 6 lumber
- 1 4-x-8-foot sheet of 1/2-inch exterior plywood
- 1 4-x-4-foot sheet of 1/2-inch exterior plywood
- 22 feet of 36-inch-wide 1/2-inch hardware cloth
- 2 pounds of 16d galvanized nails
- 250 poultry wire staples (or a power stapler with 1-inch galvanized staples)
- 12 1/2-inch carriage bolts 4 inches long
- 12 washers and 12 nuts for the bolts
- 6 3-inch zinc-plated hinges
- 24 washers and 24 nuts for the hinges
- 1 quart wood preservative or stain

### Tools

- tape measure
- hand saw or circular power saw
- hammer
- tin snips
- carpenter's square
- optional: power stapler with 1-inch galvanized staples
- drill with 1/2-inch bit
- screwdriver
- 3/4-inch socket or open-ended wrench
- pencil
- safety glasses
- ear protection
- dust mask
- work gloves

## Building a Wood and Wire Three-Bin System

1. Cut two 31 1/2-inch and two 36-inch pieces from a 12-foot length of pressure-treated 2 x 4 lumber. Butt joint and nail the four pieces into a 35-inch x 36-inch "square." Repeat, building three more frames with the remaining 12-foot lengths of 2 x 4 lumber.

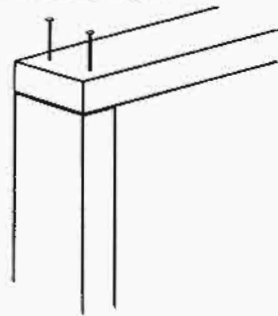

2. Cut four 37-inch lengths of hardware cloth. Fold back the edges of the wire 1 inch. Stretch the pieces of hardware cloth across each frame. Make sure the corners of each frame are square and then staple the screen tightly into place every 4 inches around the edge. The wood and wire frames will be dividers in your composter.

continued on next page

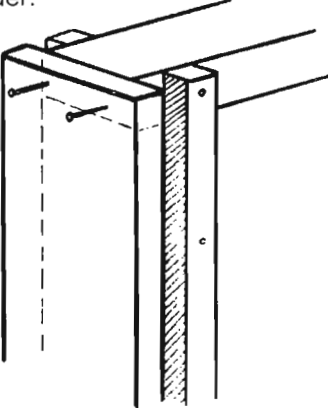
3. Set two dividers on end 9 feet apart and parallel to one another. Position the other two dividers so they are parallel to and evenly spaced between the end dividers. The 36-inch edges should be on the ground. Measure the position of the centers of the two inside dividers along each 9-foot edge.
  4. Cut a 9-foot piece from each 10-foot length of pressure-treated 2 x 4 lumber. Place the two treated boards across the tops of the dividers so each is flush against the outer edges. Measure and mark on the 9-foot boards the center of each inside divider.
  5. Line up the marks, and through each junction of board and divider, drill a 1/2-inch hole centered 1 inch in from the edge. Secure the boards with carriage bolts, but do not tighten them yet. Turn the unit so the treated boards are on the bottom.
  6. Cut one 9-foot piece from the 10-foot length of construction grade 2 x 4 lumber. Attach the board to the back of the top by repeating the process used to attach the base boards. Using the carpenter's square or measuring between opposing corners, make sure the bin is square. Tighten all the bolts securely.
  7. Fasten a 9-foot length of hardware cloth to the back side of the bin with staples every 4 inches around the frame.
  8. Cut four 36-inch-long pieces from the 16-foot length of 2 x 6 lumber for front runners (Save the remaining 4-foot length.) Rip cut two of these boards to two 4 3/4-inch-wide strips. (Save the two remaining strips.)
  9. Nail the 4 3/4-inch-wide strips to the front of the outside dividers and baseboard so they are flush on the top and the outside edges. Center the two remaining 6-inch-wide boards on the front of the inside dividers flush with the top edge and nail securely.
  10. Cut the remaining 4-foot length of 2 x 6 lumber into a 34-inch-long piece and then rip cut this piece into four equal strips. Trim the two strips saved from step 8 to 34 inches. Nail each 34-inch strip to the insides of the dividers so they are parallel to and 1 inch away from the boards attached to the front. This creates a 1-inch vertical slot on the inside of each divider.
- 
11. Cut the 6 8-foot lengths of 1 x 6 lumber into 18 slats, each 31 1/4 inches long. Insert the horizontal slats, 6 per bin, between the dividers into the vertical slots.
  12. Cut the 4-x-8-foot sheet of exterior plywood into two 3-x-3-foot pieces. Cut the 4-x-4-foot sheet of exterior plywood into one 3-x-3-foot piece. Center each 3-x-3-foot piece on one of the three bins and attach each to the back top board with two hinges.
  13. Stain all untreated wood.

## Adding Wastes

Do not add wastes as they become available with this system. Collect enough wastes to fill one of the three bins at one time. You can collect woody as well as nonwood wastes. Add thin layers of different kinds of organic materials or mix the wastes together.

Before adding new wastes to an empty bin, collect enough to fill the entire bin.

## Maintaining Your Compost Pile

Take the temperature of your pile every day. After a few days, the temperature should reach between 130° and 140°F (54° to 60°C). If your pile gets very hot, turn it before the temperature gets above 155°F (68°C). In a few days, the temperature will start to drop. When the temperature starts going down, turn your compost pile into the next bin with a pitchfork. The temperature of your compost pile will increase again and then, in about four to seven days, start to drop. Turn your compost pile into the third bin. The total time for composting should be less than one month.

# Cinder Block Bin

A cinder block bin is sturdy, durable, and easily accessible. If you have to buy the cinder blocks, it is slightly more expensive to build than the wire mesh or snow fence bins.

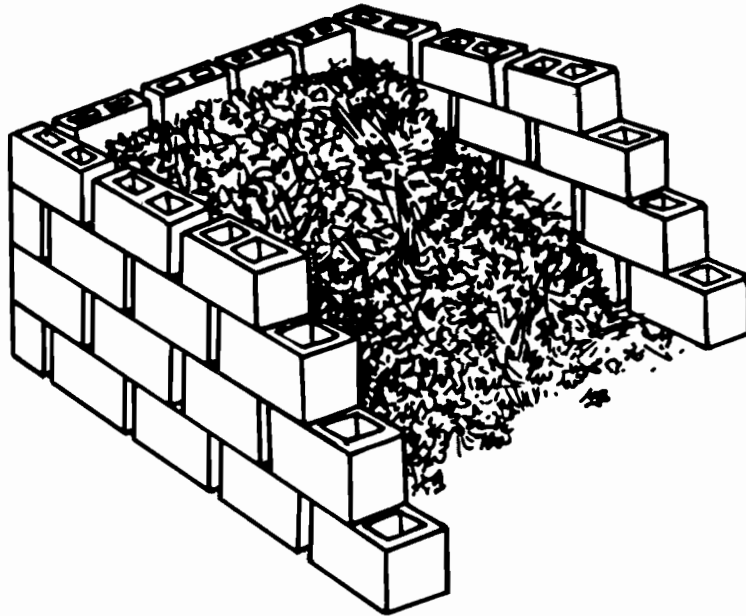

---

## What You Need

- about 46 cinder blocks for the first bin
- optional: about 32 blocks for a second bin
- work gloves

## Building a Cinder Block Bin

1. Place 5 cinder blocks in a row along the ground at your composting site, leaving about 1/2 inch between each block to let in air.
2. Place 4 cinder blocks in another row along the ground perpendicular to and at one end of the first row, forming a square corner; leave about 1/2 inch between each block.
3. In the same way, place 4 cinder blocks at the opposite end of the first row to form a three-sided enclosure.
4. Add a second layer of blocks, staggering them to increase stability and leaving about 1/2 inch

between each block. There should be a layer of 4 cinder blocks on each of the three walls of the enclosure.

5. Add a third layer of blocks, again staggering them to increase stability, with 5 blocks across the back of the enclosure and 3 on each side.
6. The last and top layer should have 4 blocks across the back and 3 on each side.
7. Optional: If you wish to decrease your composting time, build a second bin next to the first so the wastes in one can mature while you add wastes to the other. Use one side wall of the first bin so you only need to build two additional walls.

## Adding Wastes

Add wastes as they become available. Nonwood materials such as grass clippings and garden weeds work best. You can speed up the process by chopping or shredding the wastes. If you have two units, when the first unit is full let the compost mature and add wastes to the second unit.

## Maintaining Your Compost Pile

Although you do not need to turn this pile, make sure that it is moist during dry spells. Compost should be ready in about one year or more.

# Cinder Block Turning Unit

A cinder block turning unit looks like three cinder block holding units in a row. It is sturdy, and if you can find used cinder blocks, it is inexpensive to build.

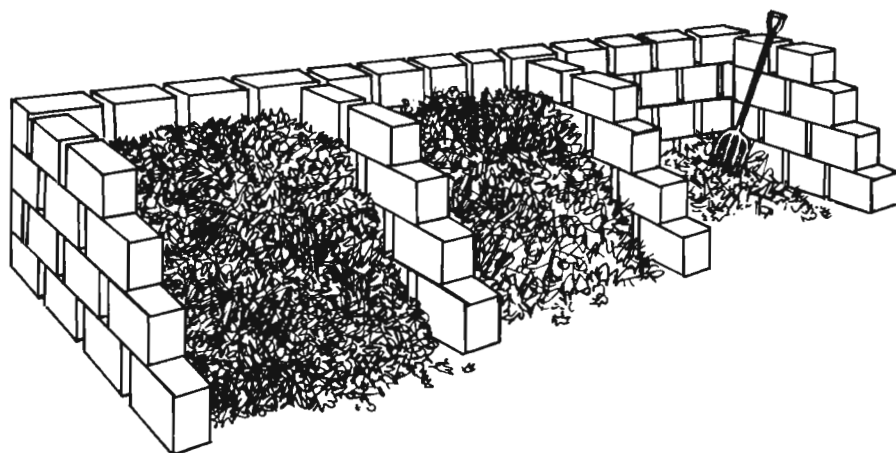

---

## What You Need

- about 98 cinder blocks
- work gloves

## Building a Cinder Block Turning Unit

1. Place 12 cinder blocks in a row along the ground at your composting site, leaving about 1/2 inch between each block to let in air.
2. Place 4 cinder blocks in another row along the ground perpendicular to and at one end of the first row, forming a square corner; leave about 1/2 inch between each block.
3. In the same way, place 4 cinder blocks at the opposite end of the first row to form a three-sided enclosure.
4. Place two more rows—4 cinder blocks each—along the ground, parallel to the ends and evenly spaced within the enclosure. This divides the enclosure into three separate bins.
5. Add a second layer of blocks, staggering them to increase stability and leaving about 1/2 inch between each block. There should be a layer of 13 cinder blocks across the back and 3 cinder blocks on the sides of each bin.
6. Add a third layer of blocks, again staggering them to increase stability, with 12 blocks across the back of the enclosure and 3 on each side.
7. The last and top layer should have 13 blocks across the back and 2 on each side.

## Adding Wastes

Do not add wastes as they become available with this system. Collect enough wastes to fill one of the three bins at one time. You can collect woody as well as nonwood wastes. Add thin layers of different kinds of organic materials or mix the wastes together.

Before adding new wastes to an empty bin, collect enough to fill the entire bin.

## Maintaining Your Compost Pile

Take the temperature of your pile every day. After a few days, the temperature should reach between 130° and 140°F (54° to 60°C). If your pile gets very hot, turn it before the temperature gets above 155°F (68°C). In a few days, the temperature will start to drop. When the temperature starts going down, turn your compost pile into the next bin with a pitchfork. The temperature of your

compost pile will increase again and then, in about four to seven days, start to drop. Turn your compost pile into the third bin. Continue to take the temperature and turn the compost pile until the compost is ready. The compost should be ready in about one or two months.

## Wire Mesh Bin

A wire mesh bin is inexpensive and easy to build out of either galvanized chicken wire or hardware cloth. (Nongalvanized chicken wire can also be used but will not last very long.) Posts provide more stability for a chicken wire bin, but make the bin difficult to move. A wire mesh bin made without posts is easy to lift, allowing you to get at the compost that is already "done" at the bottom of the pile while the top of the pile is still cooking.

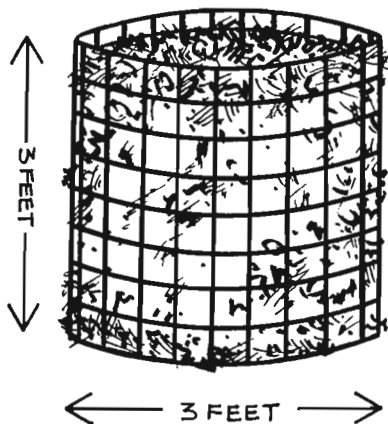

### What You Need

#### Materials

- 12 1/2 feet of 36-inch-wide 1-inch galvanized chicken wire or 1/2-inch hardware cloth
- heavy wire for ties
- 3 or 4 4-foot wooden or metal posts (for chicken wire bin)

#### Tools

- heavy-duty wire or tin snips
- pliers
- hammer (for chicken wire bin)
- metal file (for hardware cloth bin)
- work gloves

## Building a Wire Mesh Bin

### If using chicken wire:

1. Fold back 3 to 4 inches of wire at each end of the cut piece to provide a strong, clean edge that won't poke or snag and which will be easy to latch.
2. Stand the wire in a circle and set it in place for the compost pile.
3. Cut the heavy wire into lengths for ties. Attach the ends of the chicken wire together with the wire ties, using pliers.
4. Space wood or metal posts around the inside of the chicken wire circle. Holding the posts tightly against the wire, pound them firmly into the ground to provide support.

### If using hardware cloth:

1. Trim the ends of the hardware cloth so the wires are flush with a cross wire to get rid of edges that could poke or scratch hands. Lightly file each wire along the cut edge to ensure safe handling when opening and closing the bin.
2. Bend the hardware cloth into a circle, and stand it in place for the compost pile.
3. Cut the heavy wire into lengths for ties. Attach the ends of the hardware cloth together with the wire ties, using pliers.

## Adding Wastes

Add wastes as they become available. Nonwood materials such as grass clippings and garden weeds

work best. You can speed up the process by chopping or shredding the wastes.

## Maintaining Your Compost Pile

As you keep adding wastes to the wire mesh bin, the material at the bottom will become compost sooner than the material at the top. If you want to use the compost at the bottom of the pile, you can remove the wire holding unit and place it next to the pile. Then, use a pitchfork to move the compost back into the

moved holding unit, adding the material from the top of the pile first. Continue until you have replaced all the compost. Now the compost at the top of the bin is ready to use.

You also can scoop finished compost from the bottom of the pile by lifting one side of the unit.

Although you do not need to turn this pile, make sure it is moist during dry spells. Compost should be finished in about one year.

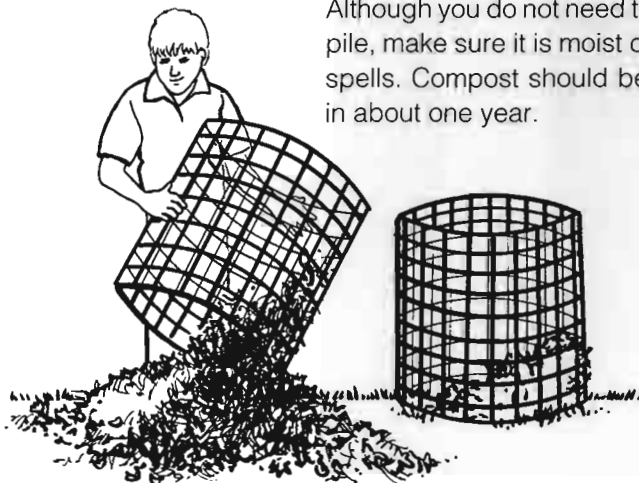

# Snow Fence Bin

A snow fence bin is simple to make. It works best with four posts pounded into the ground for support.

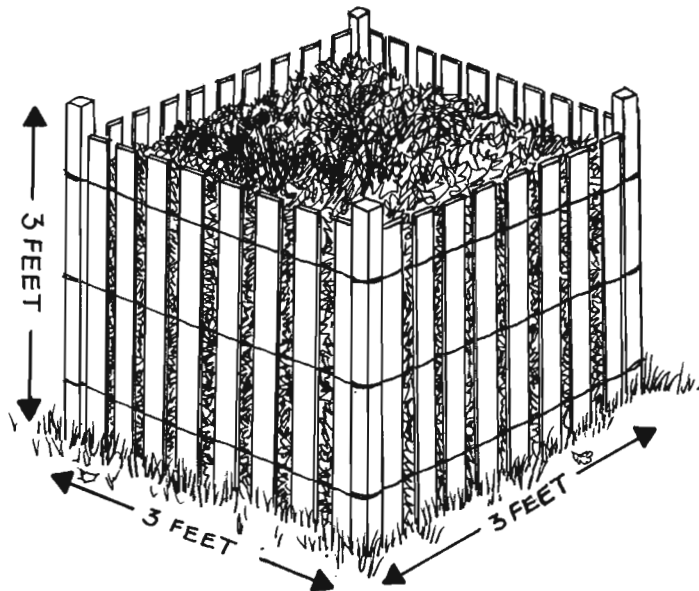

---

## What You Need

### Materials

- 4 wooden or metal posts, at least as tall as the snow fence
- heavy wire for ties
- 12 1/2 feet of snow fencing, at least 3 feet tall

### Tools

- heavy-duty wire or tin snips
- pliers
- sledge hammer
- work gloves

## Building a Snow Fence Bin

1. Choose a 3-foot-square site for your compost bin, and pound the four wooden or metal posts into the ground 3 feet apart, at the corners of the square.
2. Cut the heavy wire into lengths for ties. Attach the snow fence to the outside of the posts with the wire ties, using pliers.
3. Attach the ends of the snow fence together in the same way, forming a 3-foot-square enclosure.

## Adding Wastes

Add wastes as they become available. Nonwood materials such as grass clippings and garden weeds work best. You can speed up the process by chopping or shredding the wastes.

## Maintaining Your Compost Pile

Although you do not need to turn this pile, make sure that it is moist during dry spells. Compost should be ready in about one year. Simply remove the fencing and the compost is ready to use.



# Garbage Can Composter

A garbage can composter is inexpensive and easy to build. It can be used for food or garden wastes. You do, however, need to turn the wastes.

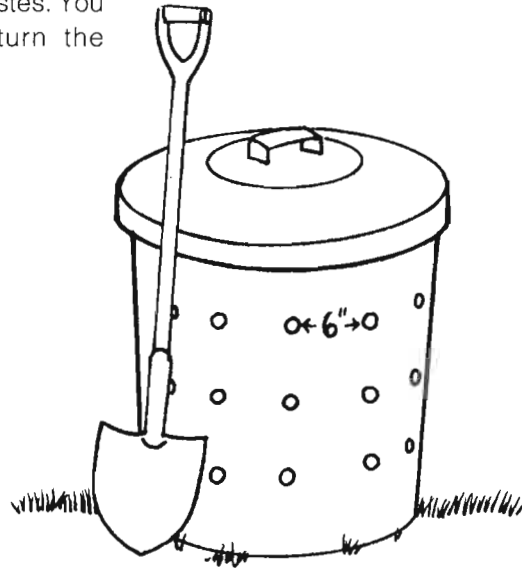

---

## What You Need

### Materials

- garbage can with cover
- coarse sawdust, straw, or wood chips

### Tools

- drill
- pitch fork, shovel, or compost turner
- work gloves

## Building a Garbage Can Composter

1. Drill three rows of holes 4 to 6 inches apart all around the sides of the garbage can. Then drill several holes in the base of the can. The holes allow air movement and the drainage of excess moisture.
2. Place 2 to 3 inches of dry sawdust, straw, or wood chips in the bottom of the can to absorb excess moisture and let the compost drain.

## Adding Wastes

Add fruit, vegetable, and garden wastes. Make sure not to add too much of any one waste at a time.

## Maintaining Your Compost Pile

Regularly mix or turn the compost with a pitch fork, shovel, or compost turner and keep it covered. This adds air and mixes up the different wastes, preventing the compost from getting smelly. A smelly compost pile may attract animals and cause neighbors to complain.

# Worm Composting Bin

Worms in the house? Yuk! But this composting system actually works! The worms stay in the box and eat household scraps, and the box gives off little odor. Worm composting can be done in apartment buildings or other homes with no yard space. You might try it in your school!

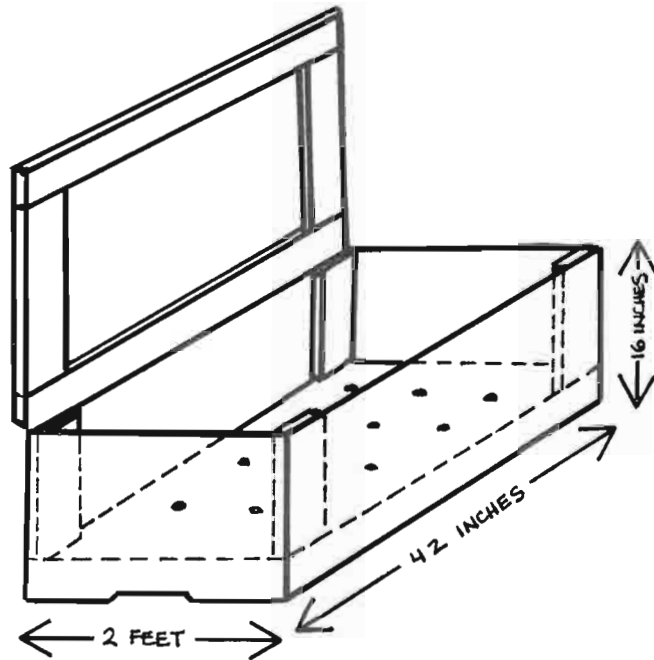

## What You Need

### Materials

- 1 4-x-8-foot sheet of 1/2-inch exterior plywood
- 1 12-foot length of 2 x 4 lumber
- 1 16-foot length of 2 x 4 lumber
- 1/2 pound of 16d galvanized nails
- 2 pounds of 6d galvanized nails
- 2 galvanized door hinges
- optional: 1 pint of clear varnish or polyurethane
- optional: plastic sheets for placing under and over the bin
- 1 pound of worms for every 1/2 pound of food wastes produced per day  
(Worms sold as fishing bait are best. Red worms are available from Flowerfield Enterprises, 10332 Shaver Road, Kalamazoo, MI 49002, 616-327-0108.)
- bedding for worms: moistened shredded newspaper or cardboard, peat moss, or brown leaves

### Tools

- tape measure
- skill saw or hand saw
- hammer
- saw horses
- long straight-edge or chalk snap line
- screwdriver
- drill with 1/2-inch bit
- eye and ear protection
- work gloves
- optional: paint brush

## Building a Worm Composting Bin

1. Measure and cut the plywood as shown, so you have one 24-x-42-inch top, one 23-x-42-inch base, two 16-x-24-inch ends, and two 16-x-42-inch sides.
2. Cut the 12-foot length of 2 x 4 lumber into five pieces: two 39-inch pieces, two 23-inch pieces, and one 20-inch piece.
3. Lay the five pieces on edge on a flat surface to form a rectangle with the long pieces on the inside and the 20-inch length centered parallel to the ends. Nail the pieces together with two 16d nails at each joint.

continued on next page

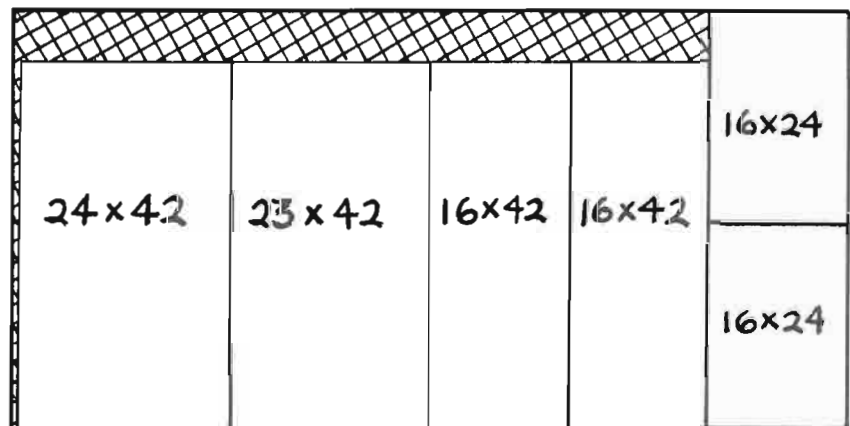

4. Nail the 23-x-42-inch piece of plywood onto the frame with 6d nails every 3 inches.
5. Cut four 1-foot lengths from the 16-foot length of 2 x 4 lumber. (Save the remaining 12-foot piece). Take the two 16-x-42-inch pieces of plywood and place a 1-foot length flat against each short end and flush with the top and side edges. Nail the 2 x 4s in place using 6d nails.
6. Set the plywood sides up against the base frame so the bottom edges of the 2 x 4s rest on top of the base frame and the bottom edges of the plywood sides overlap the base frame. Nail the plywood sides to the base frame using 6d nails.
7. To complete the box, nail the 16-x-24-inch pieces of plywood onto the base and sides at each end.
8. To reinforce the box, make sure a nail is staggered at least every 3 inches wherever plywood and 2 X 4s meet.
9. Drill 12 one-half-inch holes through the plywood bottom of the box for drainage.
10. To build the frame for the lid, cut the remaining 12-foot piece of the 16-foot length of 2 x 4 lumber into two 45-inch pieces and two 20-inch pieces. Lay the pieces flat to form a rectangle, with the short pieces on the inside.
11. Lay the 24-x-42-inch piece of plywood on top of the lid frame so the plywood is 1 1/2 inches inside all the edges of the frame. Nail the plywood onto the frame with 6d nails.
12. Attach the hinges to the inside of the back of the box at each end (on the 2 x 4) and the corresponding undersides of the back edge of the lid frame, so the lid stands upright when opened.
13. The unfinished box should last for at least five years; finishing the box with varnish or polyurethane, however, will protect the wood and prolong the life of the box. Two coats of varnish with a light sanding between coats should be sufficient.
14. Find a good location for the box. It can be placed anywhere as long as the temperature is more than 50°F (10°C). The most productive temperature is 55° to 77°F (13° to 25°C). Garages, basements, and kitchens are all possibilities as well as the outdoors in warm weather (not in direct sunlight). Make sure to place the box where it is convenient for you to use. It is wise to place a plastic sheet under the box.

---

## **Adding the Worms**

Moisten the bedding material for the worms by placing it in a 5-gallon bucket and adding enough water to dampen all the material. Don't worry about getting the bedding material too wet because the excess moisture will drain off when it is placed into the composting bin. Be careful if you use peat moss because it will hold too much water. It is a good idea to put wet bedding material into the bin outdoors and wait until all the water has drained out (one to two hours).

Add about 8 inches of moistened bedding to the bottom of one side of the bin. In go the worms! Leave the lid off for a while and the worms will work down into the bedding away from the light.

## **Adding Your Wastes**

Dig a small hole in the bedding and add your vegetable and fruit scraps. Then cover the hole with bedding. Small amounts of meat scraps can be added in the same way. Do not add any inorganic or potentially hazardous material such as chemicals, glass, metal, or plastic.

## **Maintaining Your Compost Pile**

Keep your compost pile moist, but not wet. If flies are a problem, place more bedding material over the wastes or a sheet of plastic over the bedding, or try placing some flypaper inside the lid. Every three to six months, move the compost to one side of the bin and add new bedding to the empty half. At this time, add food wastes to the new bedding only. Within one month, the worms will crawl over to the new bedding and the finished compost on the "old" side can be harvested. Then add new bedding to the "old" side.

## Compost Mound

Yard wastes can be composted without a bin if you don't mind the appearance of an uncontained compost mound in your yard. The only costs are your time and work.

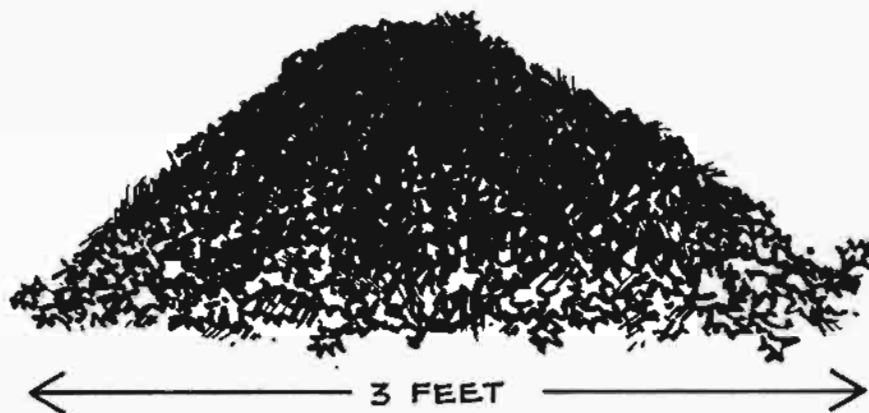

---

### What You Need

- shovel or pitchfork
- work gloves

### Building a Compost Mound

Find a good location and pile your yard waste in a mound about 3 feet x 3 feet x 3 feet (1 meter x 1 meter x 1 meter). If you cover the pile with a layer of soil, it will keep in moisture for the microorganisms and soil animals working to make compost.

### Adding Wastes

Add wastes as they become available. Nonwood materials such as grass clippings and garden wastes work best.

### Maintaining Your Compost Pile

It is best to have two piles. After the first pile is large enough, stop adding organic material and let it work. In the meantime, add your wastes to the second pile.

Make sure the pile is moist, especially if it is not covered with soil.

You can turn the pile to speed up composting. Compost should be ready in three to four months if you turn the pile, or in about one year if you don't turn the pile.

# Compost Pockets

This is an easy composting shortcut. You bury your fruit and vegetable wastes in small pockets in your garden, and let the microorganisms and soil animals do the work. Store your kitchen scraps in a plastic container until you are ready to compost them.

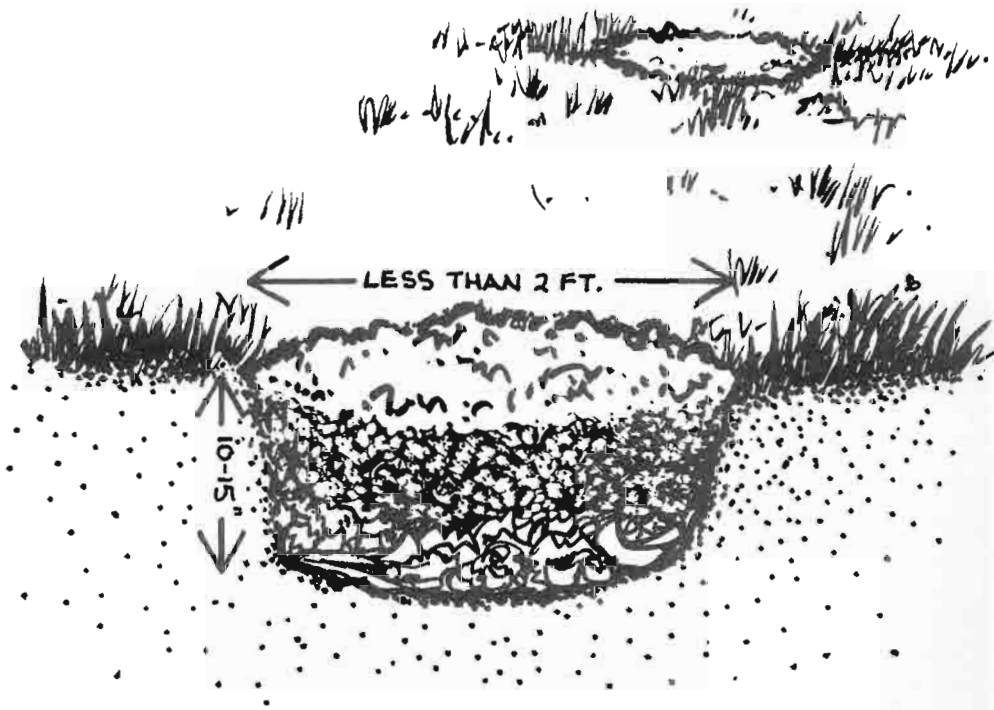

---

## What You Need

### Materials

- food wastes, collected in a plastic container or bucket

### Tools

- shovel
- work gloves

## What to Do

1. Dig holes 10 to 15 inches deep and less than 2 feet across.
2. Place food wastes in the holes and cover with soil. Make sure the soil cover is at least 8 inches deep so the buried materials do not attract animals.

# Mulch

Mulch is placed on top of the soil in gardens or around trees to suppress weeds, keep soil moist, keep plant roots cool in summer and warm in winter, and prevent soil from washing away or becoming hard. Yard wastes can be used as mulch and placed around plants in the garden or along paths and in play areas. The only costs are your time and work. You can also mulch with compost made using one of the systems described in the leader's/teacher's guide.

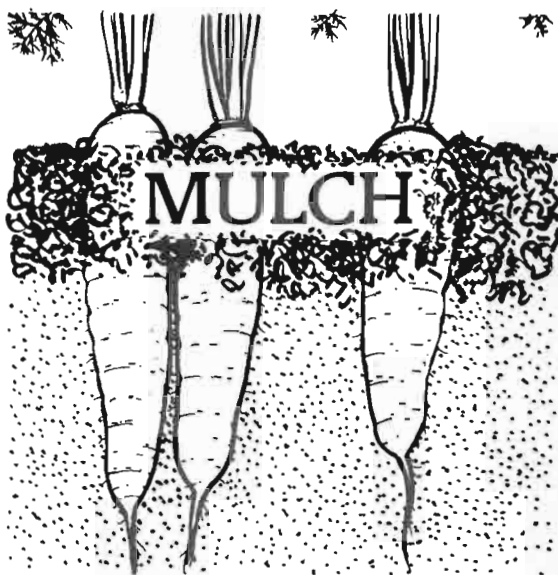

## What You Need

### Materials

For annual flower beds and vegetable gardens:

- lawn clippings or leaves from deciduous trees and shrubs

For trees and shrubs:

- wood chips, lawn clippings, sawdust, leaves from deciduous trees and shrubs, pine needles, manure

For pathways and play areas:

- wood chips or sawdust

### Tools

- shovel
- wheel barrow
- rake
- work gloves

## What to Do

1. Spread your mulch in the garden, around the base of a tree, or in a path or play area. Rake it smooth.
2. Place mulch around the trees as illustrated in the diagram. Mulching trees helps keep moisture in the soil and protects plants during cold weather.

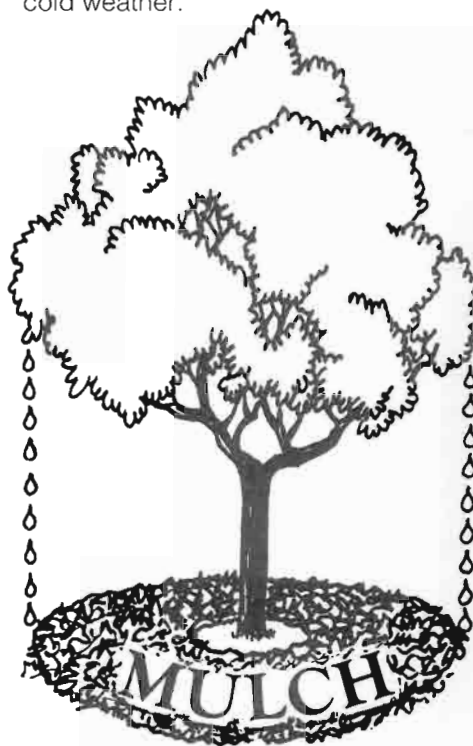



## Compost Project Record

Name: \_\_\_\_\_

Date: \_\_\_\_\_

Type of compost system used (include a diagram):

Wastes added to compost pile:

Any problems? How did you solve them?

What did you learn from your compost project?